

FOR **MUELLER**

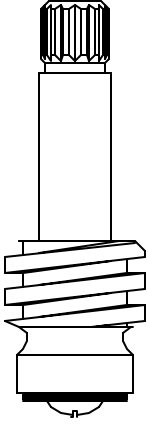

259061
259062

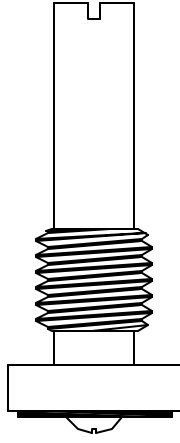

201141

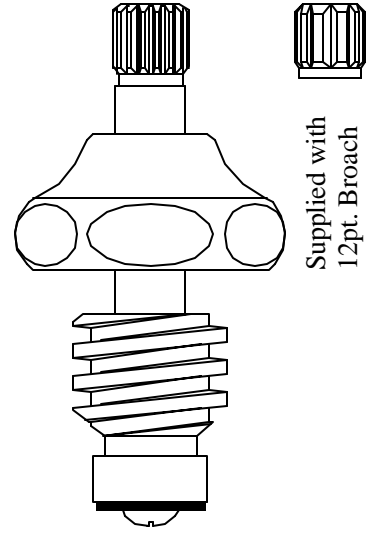

Supplied with
12pt. Broach

401451

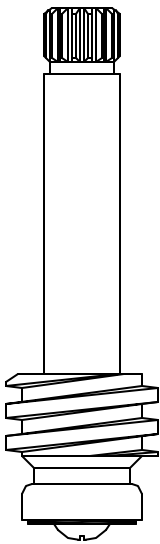

201411

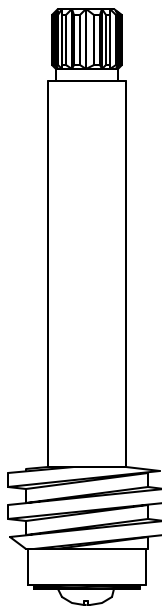

267191

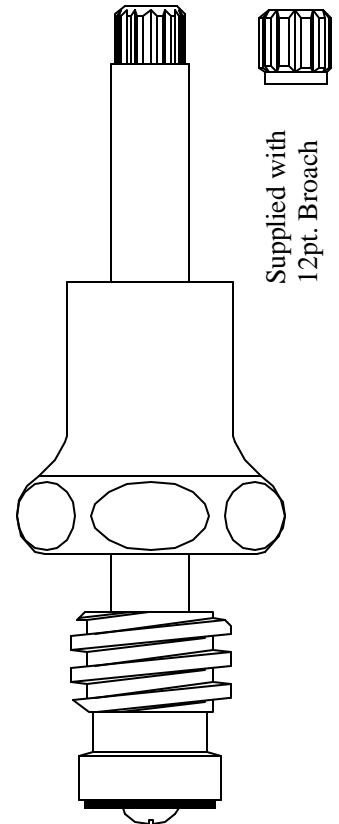

Supplied with
12pt. Broach

405051

FOR MUELLER

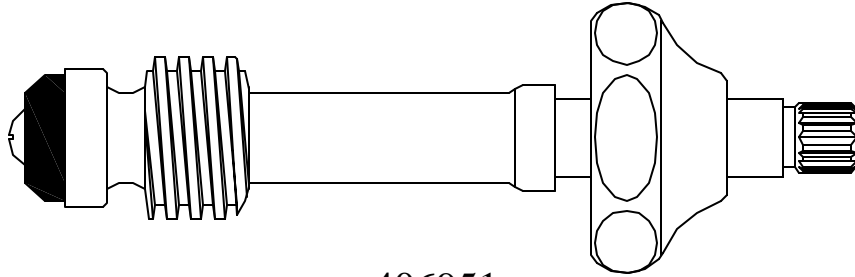

406951

Supplied with
12pt. Broach

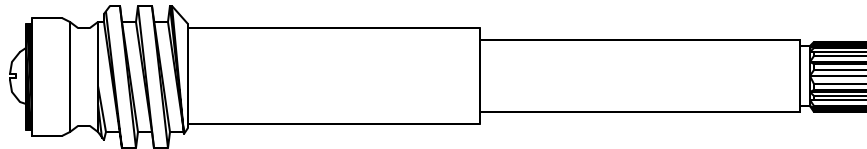

271061

Supplied with
12pt. Broach

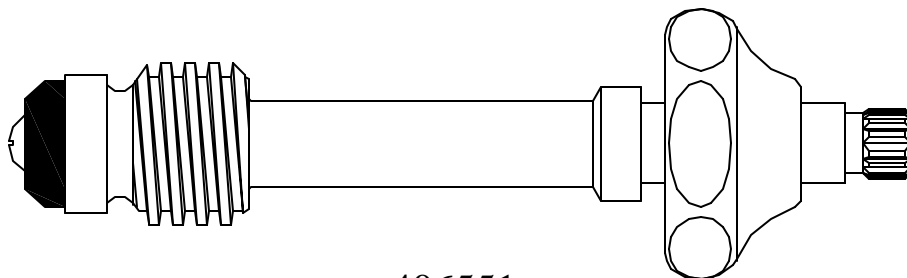

406551

Supplied with
12pt. Broach

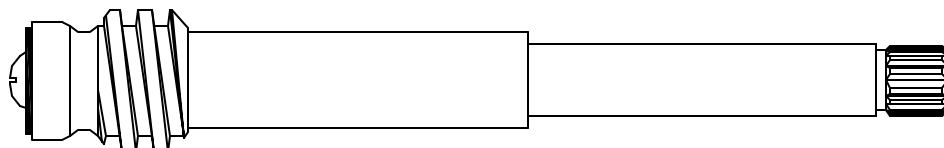

274061

Supplied with
12pt. Broach



FOR MUELLER

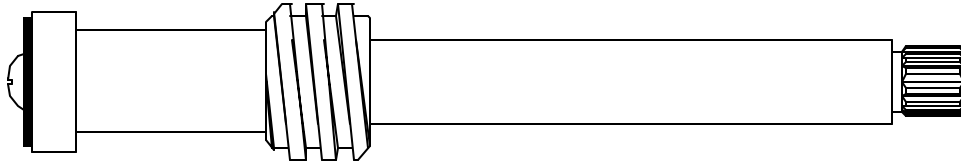

210021

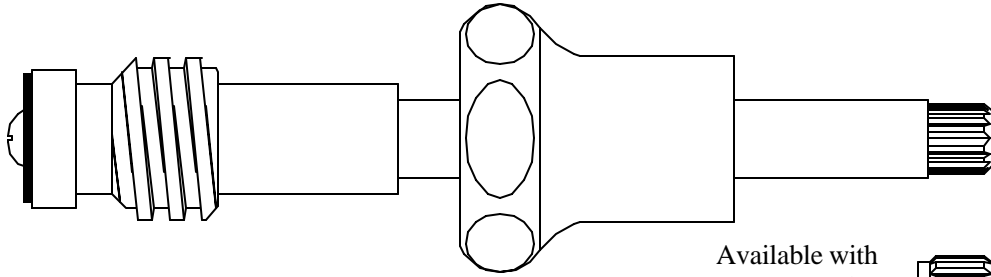

414801

Available with
12pt. Broach
414851

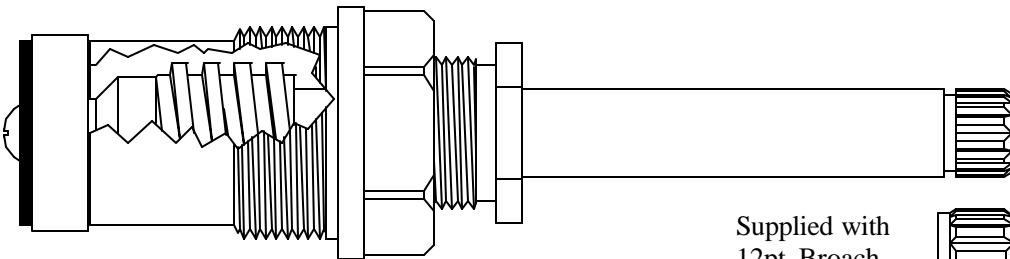

413451

Supplied with
12pt. Broach

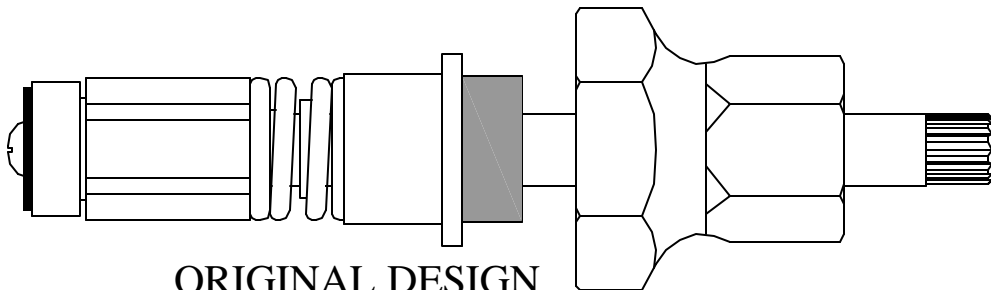

ORIGINAL DESIGN
USE 414751

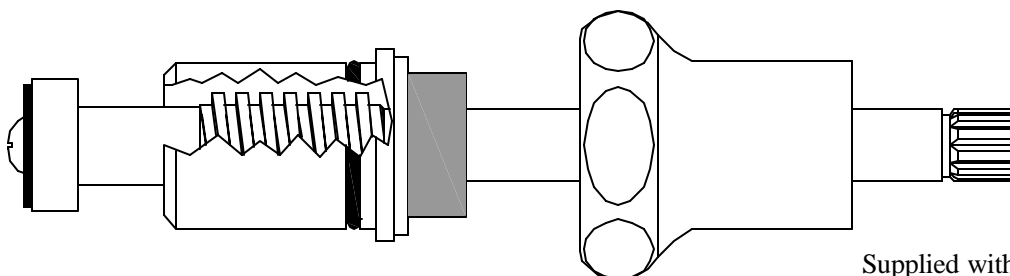

414751

Supplied with
12pt. Broach

FOR MUELLER

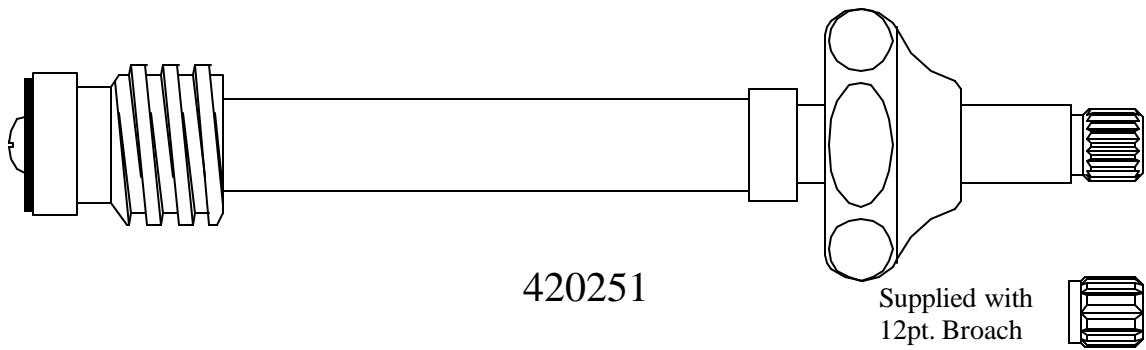
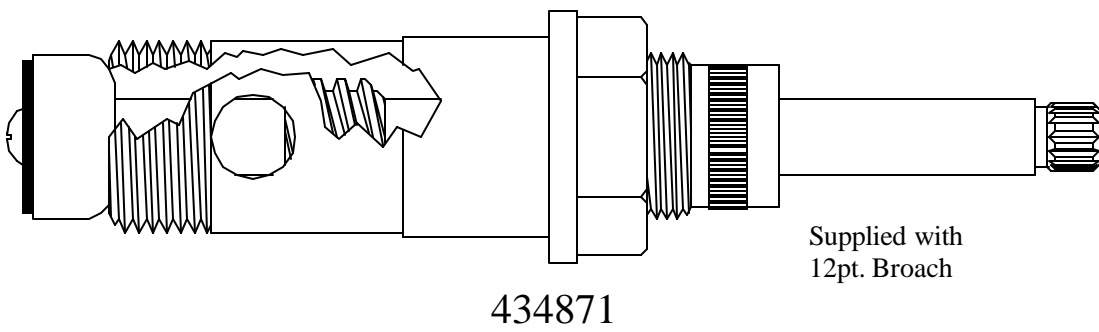
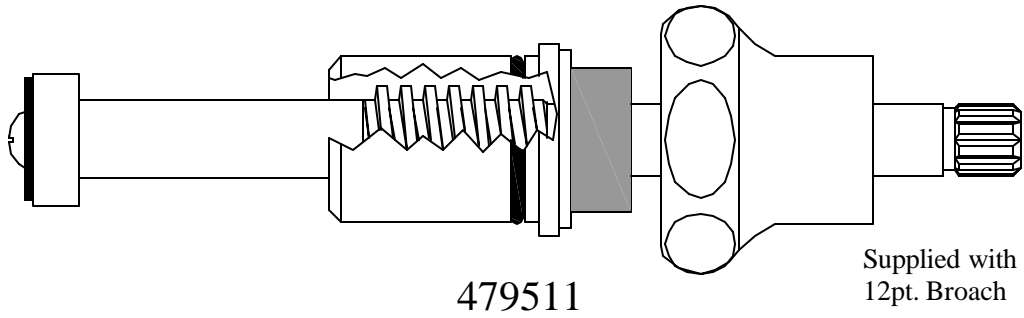
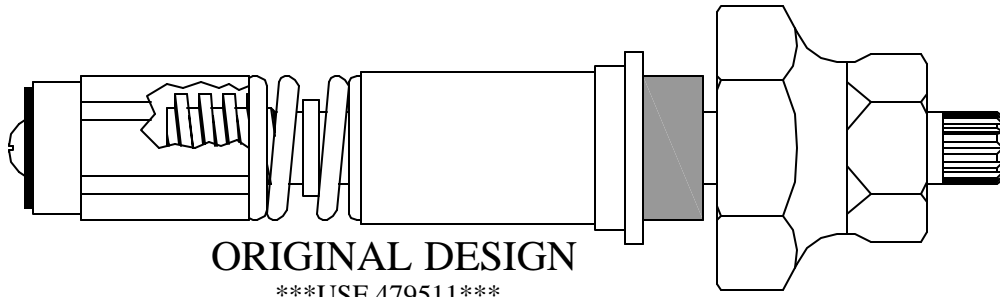

FOR MUELLER

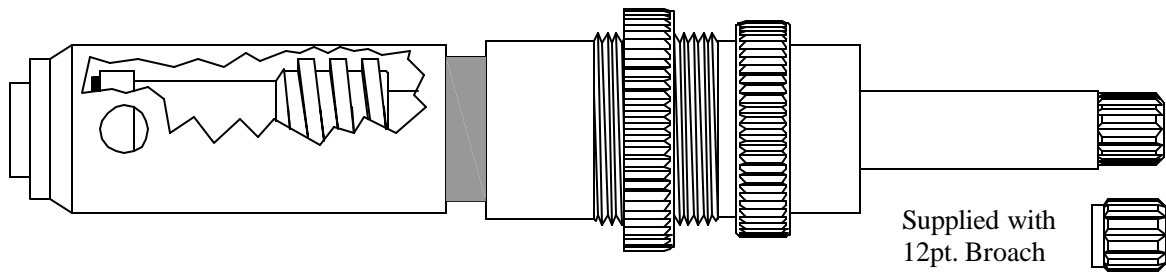

423451

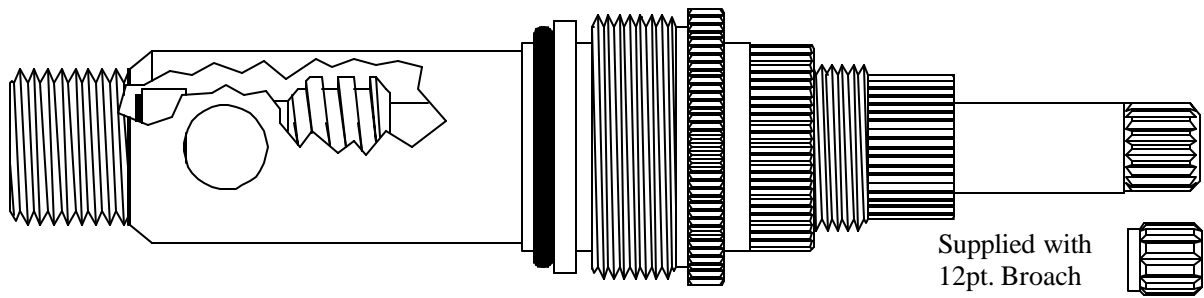

422751

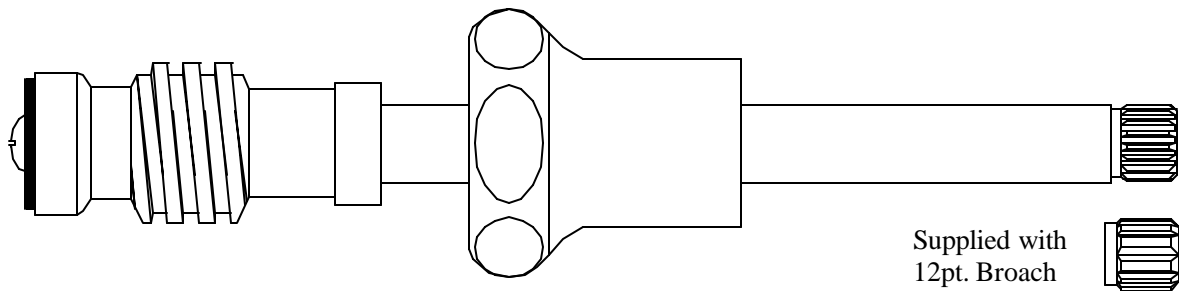

426161

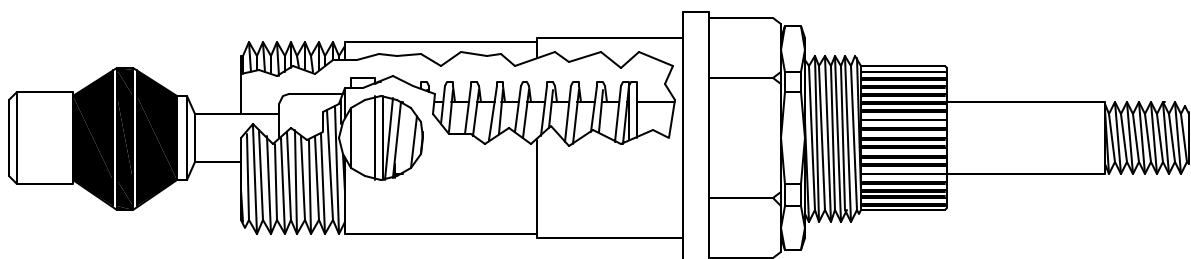

438200

FOR **MUELLER**

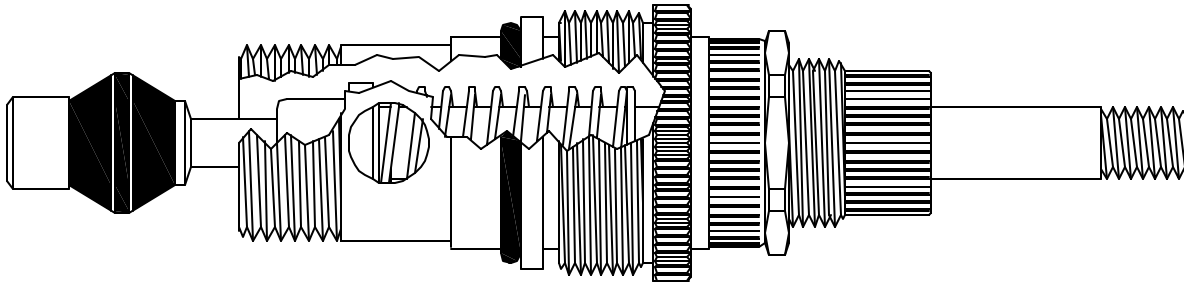

438210

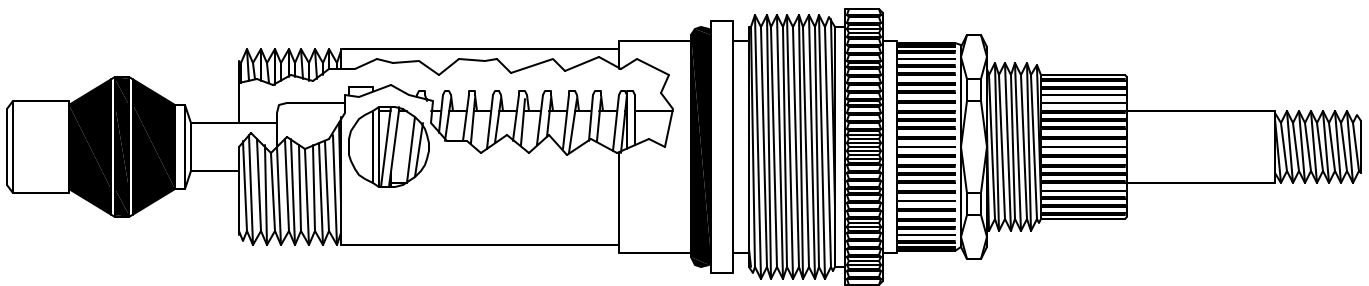

439640

BARRY E.  **WALTER** SR. CO.
SUPERIOR QUALITY REPLACEMENT PARTS

1-800-767-5552 fax 970-867-0902

BARRY E.  **WALTER** SR. CO.
SUPERIOR QUALITY REPLACEMENT PARTS

1-800-767-5552 fax 970-867-0902